

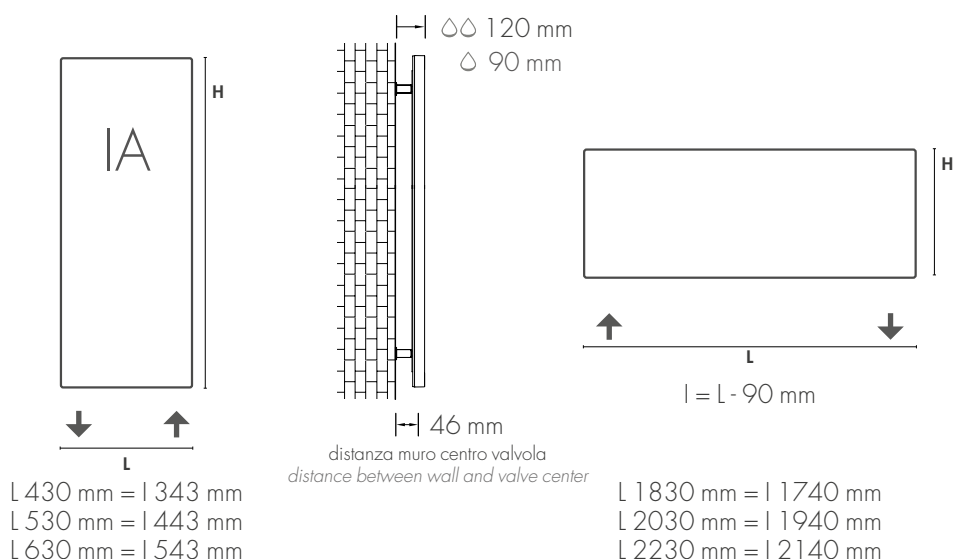



















APOLLO

disponibile in versione elettrico ed idraulico  
available in electric or hydraulic version



L (mm)	H (mm)	WATT $\Delta$ t50	VERSION	MODEL
420	920	301	☹	hydraulic single
420	1220	402	☹	hydraulic single
420	1420	469	☹	hydraulic single
420	1820	603	☹	hydraulic single
420	2020	670	☹	hydraulic single
420	2220	737	☹	hydraulic single
520	920	377	☹	hydraulic single
520	1220	502	☹	hydraulic single
520	1420	587	☹	hydraulic single
520	1820	755	☹	hydraulic single
520	2020	838	☹	hydraulic single
520	2220	1106	☹	hydraulic single
620	920	452	☹	hydraulic single
620	1220	603	☹	hydraulic single
620	1420	713	☹	hydraulic single
620	1820	905	☹	hydraulic single
620	2020	1010	☹	hydraulic single
620	2220	1160	☹	hydraulic single
430	930	472	☹☹	hydraulic double
430	1230	630	☹☹	hydraulic double
430	1430	735	☹☹	hydraulic double
430	1830	945	☹☹	hydraulic double
430	2030	1050	☹☹	hydraulic double
430	2230	1445	☹☹	hydraulic double
530	930	590	☹☹	hydraulic double
530	1230	787	☹☹	hydraulic double
530	1430	920	☹☹	hydraulic double
530	1830	1182	☹☹	hydraulic double
530	2030	1310	☹☹	hydraulic double

## Living area

L (mm)	H (mm)	WATT $\Delta t50$	VERSION	MODEL
530	2230	1556		hydraulic double
630	930	704		hydraulic double
630	1230	945		hydraulic double
630	1430	1102		hydraulic double
630	1830	1418		hydraulic double
630	2030	1577		hydraulic double
630	2230	1738		hydraulic double
L (mm)	H (mm)	WATT	VERSION	MODEL
530	1430	500		electric BASIC
530	1430	500		electric EASY1
530	1430	500		electric SMART
530	1830	750		electric BASIC
530	1830	750		electric EASY1
530	1830	750		electric SMART
630	1430	750		electric BASIC
630	1430	750		electric EASY1
630	1430	750		electric SMART
630	1830	1000		electric BASIC
630	1830	1000		electric EASY1
630	1830	1000		electric SMART

BASIC



Resistenza in classe II.  
Resistance in class II.

EASY 1



La versione EASY 1 elettrica.  
The EASY 1 electric version includes.

SMART



Termostato e ricevitore in modalità Wireless.  
Wireless thermostat and receiver.



Colori **FEEL** // Color **FEEL**



per richiedere altri interessi o misure personalizzate contattare ufficio tecnico // for other valves distance or custom dimensions please contact technical office