

WELLNESS



COBRILLO

GALATHEA

Scheda tecnica - [Data sheet](#)

GALATHEA

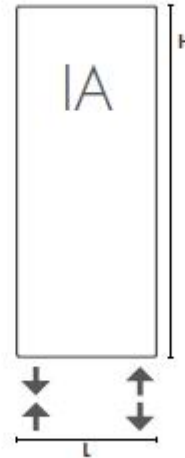

$l = 343 \text{ mm}$
disponibile/available $l = 50 \text{ mm}$

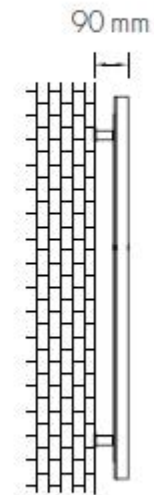

INTERASSE VALVOLE (1)
VALVE CENTER DISTANCE (1)

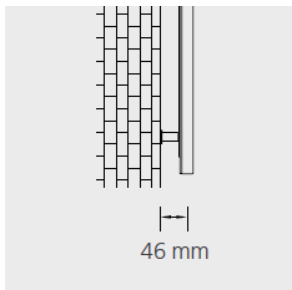

INTERASSE MURO CENTRO VALVOLA
DISTANCE BETWEEN WALL AND VALVE CENTER



Body

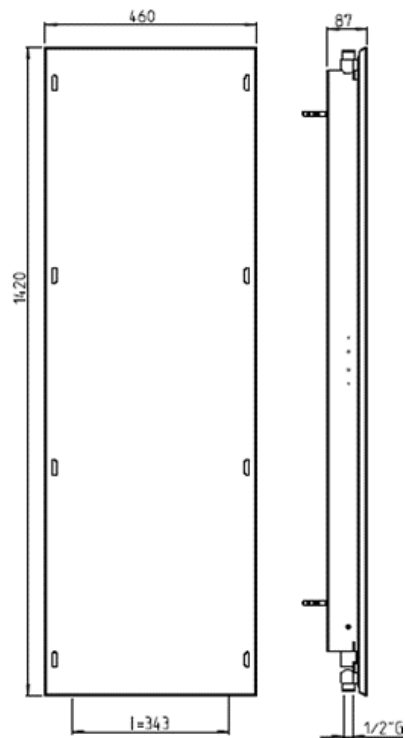

Cover

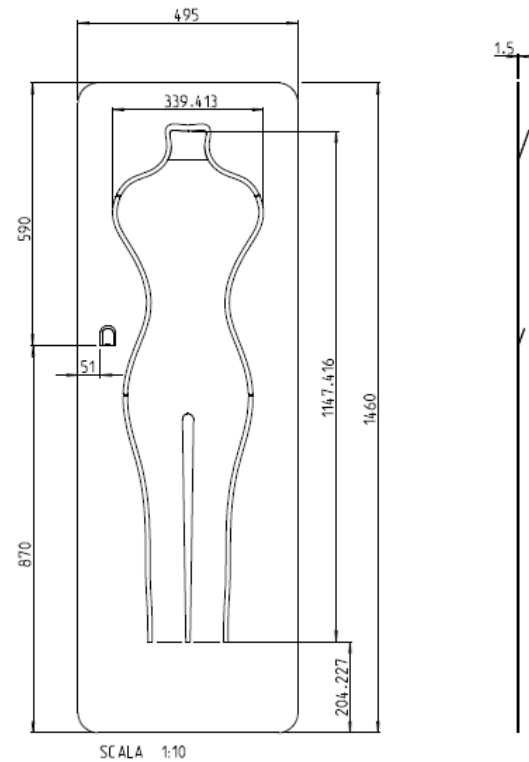

Body H = 1420 mm



Body

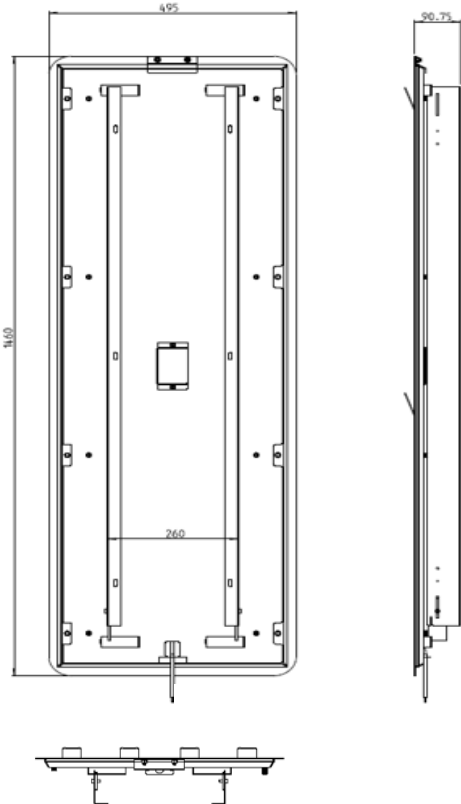

Cover

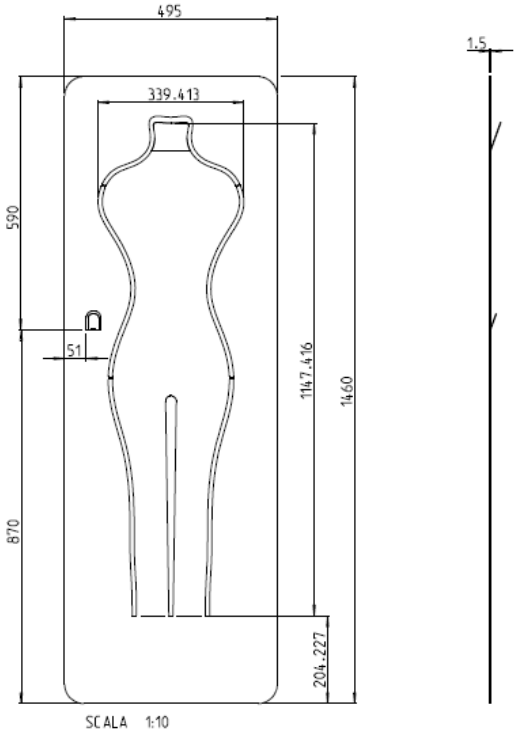

Body H = 1420 mm

Mod. 01204601420EAO
 220 - 240 V ~ 50/60 Hz 700W IP21











DIMENSIONI - DIMENSION



NAME	CODE	L	H	W	COLOR	VERSION
BODY	01204601420EA0STR7044OP	0460	1420	700	7044	SMART BASIC
BODY	01204601420EA2STR7044OP	0460	1420	700	7044	SMART SMART
BODY	01204601820EA0STR7044OP	0460	1820	900	7044	BASIC BASIC
BODY	01204601820EA2STR7044OP	0460	1820	900	7044	SMART SMART
BODY	01204601420IIASTR7044OP	0460	1420	573	7044	Water drop icon
BODY	01204601820IIASTR7044OP	0460	1820	783	7044	Water drop icon
GALATHEA	00304951460000STR9016OP	0495	1460	-	9016	N.D.

COLORI - COLORS

STANDARD COLOR	OPZIONI COLORI COLOR OPTIONS
<p>per tutti i prodotti: for all products:</p> <p>Ral 9016 OP</p> 	<p>per collezione body&cover: for body and cover collections:</p> <p>+15%*</p> <p>Ral 7006</p> 
<p>solo per la collezione body: only for body collection:</p> <p>BODY</p> <p>Ral 7044 OP</p> 	<p>Ral 7015</p> 
<p>Ral 9016 OP</p> 	<p>Ral 7023</p> 
	<p>Ral 7044</p> 
	<p>Ral 9005</p> 

VERSIONE SMART – SMART VERSION





COBRILLO

Cobrillo s.r.l.
via Torrione 30/I - 28021 BORGOMANERO - NO
Tel. 0322068247
E-mail info@cobrillo.com
C.F. e Partita IVA 02549080030
Reg. Imprese - Nr. REA
www.cobrillo.com